

AFC-330

Automated Fundus Camera



Designed and Manufactured by NIDEK – Represented by MARCO

The Power to Simply Perform



Mission

Introducing the new **AFC-330**, a 40-year pedigree of research and development that redefines the science of non-mydratric fundus cameras. Combined quantum leaps in operator and patient interface, simplicity, automation, and total practice efficiencies, make this instrument a revolutionary advancement in retinal imaging.

Nidek is universally recognized as one of the largest manufacturers of ophthalmic products with a diverse range of diagnostic and surgical devices. Marco has forged a strong relationship with Nidek through outstanding product sales and support and for over three decades has established its position in the U.S. as the leader in vision diagnostics. This enhanced collaboration between these two leading companies fundamentally increases their ability to better serve the industry.

Founded in Jacksonville, FL, in 1967, Marco continues to expand its position as *The Leader in Vision Diagnostics* with a product line that encompasses classical lane equipment and Nidek high-tech, automated refractive and retinal instrumentation. Marco continues to provide unparalleled training and support to its expanding U.S. customer base.



“We couldn’t be more excited about adding the Nidek AFC-330 automated fundus camera to our full product line of diagnostic technologies. The AFC-330 fits perfectly into Marco’s successful model of increasing efficiency with the kind of powerful, easy-to-use, and high-quality instrumentation that our customers have come to expect.”

David Marco, President and CEO of Marco



*The AFC-330 represents the rare union of the latest technology and ergonomic design – truly **The Art of Eye Care***



Designed and Manufactured by NIDEK – Represented by MARCO

Functional Simplicity

Modern Design

The large color touchscreen interface on the **AFC-330** places all functions at the operator's fingertips with intuitive menus and icons. Exam type, patient selection, database edits, and image review are all possible on the **AFC-330's** screen.

- Large 8.4" tilting, color touchscreen
- Small footprint with stand-alone operation
- One of the fastest automatic cameras on the market



Intuitive Color Touchscreen

All in One

The integrated high-resolution imaging sensor and internal PC remove the complicated cabling, allowing the **AFC-330** to communicate via LAN without the need of an external PC in the screening area, thereby maximizing office space efficiency.

Operator Guidance Features

The **AFC-330** possesses the most advanced automatic features without giving up the manual override operation for certain clinical needs. All automatic features can be set as *fully automatic*, *semi-automatic*, or *fully manual* modes of operation.

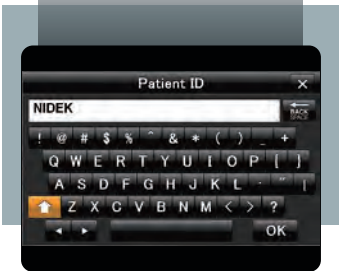

Patient List Entry



Anterior Eye Monitoring



Patient Position Indicator

The image interval indicator displays the time lapse between photos as well as pupil-size reticle. In both automatic and manual mode the **AFC-330** provides the operator with on-screen directional indicators. The anterior monitor ensures patient position during retinal focusing.

Applied Automation

The Advanced Fundus Camera

The **AFC-330**'s automated functions forge new ground in fundus imaging technology with focus on capturing the perfect picture every time, regardless of operator experience or skill level. The **AFC-330** makes numerous command calculations per second. Only this level of automation can account for the speed of operation and accuracy of this camera – the essential foundation of practice efficiency.

Three-Dimensional Automatic Alignment

- **AutoTrack** – patient movements are detected and followed automatically
- **AutoFocus** – for maximum ease of use
- **AutoShot** – when optimal conditions are met, the photo is acquired

Being equipped with this level of sophistication, the **AFC-330** is able to align and automatically switch from anterior to posterior focusing.

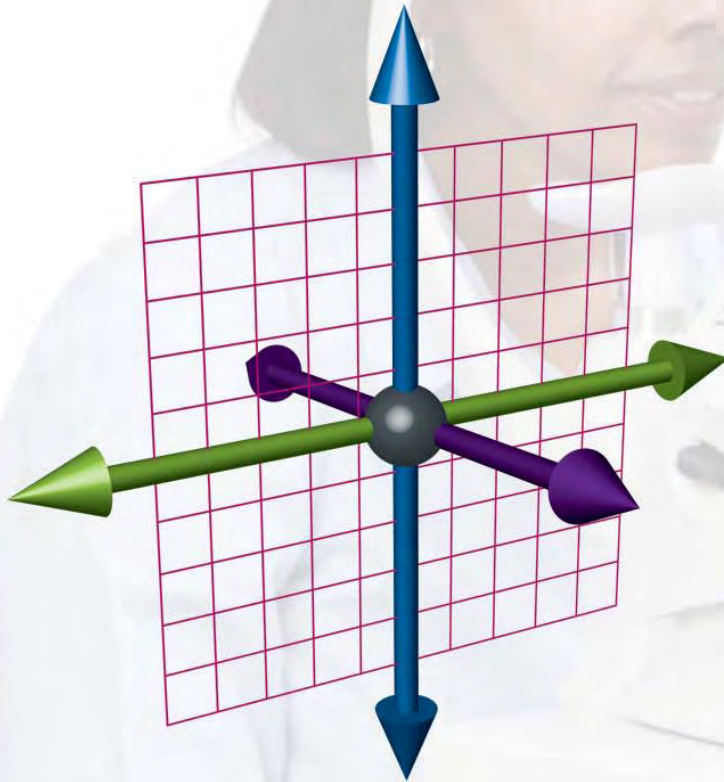

*A signature of Nidek instruments, the **AFC-330** tracks and adjusts to patient movements automatically in all three axes.*



3D AutoAlign



AutoSwitching



AutoFocus



AutoShot

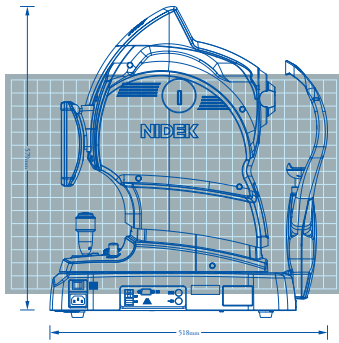

Designed as a Highly Automated Device



External Photography Mode

Benefits of Advanced Automation

The **AFC-330** delivers unsurpassed ease of use with advanced features that enhance the management of retinal disease, such as glaucoma and diabetic retinopathy.

Available modes include:



AutoStereo Pairing – separation and focal adjustments without user intervention



AutoPanoramic Imaging – seven fields, performed with automatic fixation adjustments



External Photography – automatic adjustments to device settings for optimized results



Single 45° – advanced or standard fixation

The **AFC-330** now offers advanced standard-of-care imaging techniques that are practical to perform without disrupting patient flow.

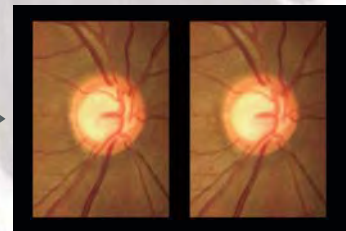

Stereo Mode for Consistent and Precise Stereo Pairs



Panorama Mode for Multi-Field, Wider-Angle Imaging

Additional Automation

- Automatic pupil measurement as well as small-pupil mode activation
- Automatic compensation lens position indicator
- AutoBlink indicator avoids image retakes
- Review and automatic transmission of captured data

Operational Efficiency

Performance and Versatility

The speed and simplicity of the **AFC-330** results in an enhanced practice flow meaning more accurate data, faster exams, and less need for retakes. The **AFC-330** fulfills the goal of elevating the patient's experience.

- Rapid processing and automated functions
- Less time at the device for patients and staff
- Fewer compromised images
- Fewer data transcription errors
- Space-saving design

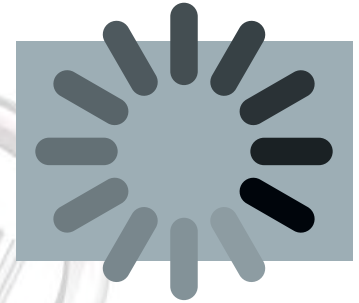

Unprecedented Speed and Simplicity

Patient Comfort

The **AFC-330** improves efficiency in time, space, and patient comfort. The lower flash intensity and sound-dampened mechanical movements, along with automatic blink and pupil measurement, make for the perfect picture every time with fewer retakes and happier patients. It is arguably one of the fastest automatic retinal cameras available with capture time often less than five seconds.

- Low-light photography mode with reduced flash intensity
- Quiet operation reduces patient anxiety, squinting, and blinking
- AutoBlink indicator
- Small-pupil mode – 3.3mm
- High-speed image capture





Seamless Connectivity

Connectivity is Key

NAVIS-EX is a fully networkable data management system with features that strengthen the diagnostic capabilities of the AFC-330's image capturing. NAVIS-EX allows seamless integration with most EMR vendors.



AutoStereo

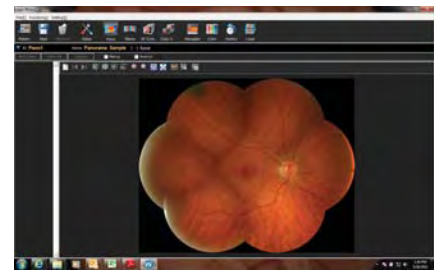

AutoMontage

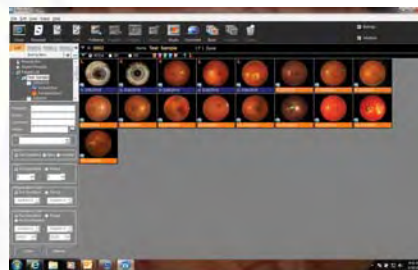

Chronological Data Review



Glaucoma Management

Data Management Flexibility

The AFC-330 provides multiple data management solutions for any practice. Its space-saving design can efficiently export information across a network without the need of an additional PC in the screening area.

- Stand-alone device
- USB 2.0 storage media, printer
- LAN connection with JPEG and XML output
- NAVIS-EX software



LAN Connection

Specifications

Main Body	AFC-330
Type	Non-mydriatic Automated Fundus Camera
Angle of view	45° (33° in small-pupil photography mode)
Working distance	45.7mm (from objective lens to cornea)
Minimum pupil diameter	ø4.0mm (ø3.3mm in small-pupil photography mode)
Dioptric compensation for patient's eyes	-33 to +35 D total -33 to -7 D with minus dioptric lens -12 to +15 D with no dioptric lens +11 to +35 D with plus dioptric lens
Focusing method	Infrared focus split alignment Adjustable range: -12 to +15 D
Light source	For observation: Halogen lamp 12V 50W For photography: Xenon flash lamp (max. 300Ws)
Flash intensity	17 levels from F1 (F4.0 +0.8 EV) to F17 (F16 +0.8 EV) 0.5 EV increments
Internal fixation target	LED (maximum 9 points)
External fixation target	Free-arm (optional)
Horizontal movement	40mm (back and forth) 85mm (left and right)
Vertical movement	32mm
Chinrest movement	62mm (up and down, motorized)
AutoTrack	X-Y-Z direction
AutoShot	Automatic image capture
Camera	Built-in 12 megapixel CCD camera
Display	Tiltable 8.4-inch color LCD touchscreen
Interface	LAN, USB 2.0
Power Supply	AC 100-240 V ±10%, 50 / 60 Hz
Power Consumption	150 VA
Dimensions • Mass	316mm (W) x 518mm (D) x 579mm (H) • 29 kg 12.4" (W) x 20.4" (D) x 22.8" (H) • 64 lbs

Specifications are subject to change without notice.



11825 Central Parkway
Jacksonville, FL 32224

800.874.5274 • 904.642.9330

www.Marco.com